



Authorised Specialists and Operators

manual

Installation and Operating Instructions

Stationary Coldwater High Pressure Cleaners

Series KS

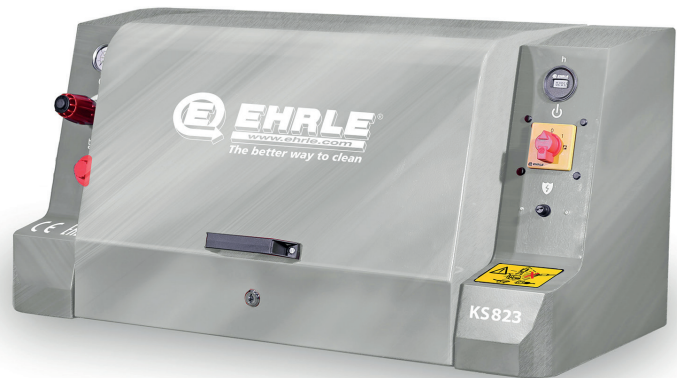

KS823-INOX-B (DE/UK)
KS1140-INOX-B (DE)



KS823-B (DE/UK)
KS1140-B (DE)

Declaration of Conformity

Manufacturer:

Ehrle GmbH

Address:

**Industriestraße 3
D – 89165 Dietenheim**

Product:

Stationary Coldwater High Pressure Cleaners
Series KS

KS823-B (DE/UK)

KS1140-B (DE)

KS823-B-INOX (DE/UK)

KS1140-B-INOX (DE)

The product given below is in conformity with the European Directives:

Relevant EC Directives:

2000/14/EC

2006/42/EC

2011/65/EU

2014/30/EU

2004/108/EC

Applied harmonized standards:

EN 60335-1

EN 60335-2-79

EN 50581

EN 55014-1: 2006+A1: 2009+A2: 2011

EN 55014-2: 2015

EN 62233: 2008

EN IEC 61000-3-2: 2019-12

EN IEC 61000-3-3: 2020-07

Conformity procedures applied:

2000/14/EG: Anhang V

**This product conforms to
the following directives:**

**UK UK
CA NI**

CE EAC CE-0085

Illertissen, 15.01.2023

Development

ppa.



Christoph Nöldner

Reiner Ehrle

Head of Development

CEO

Table of content

1	User information	
1.1	General	5
1.2	Functional device concept.....	5
1.3	Terminology.....	6
1.4	Meaning of the emphasis.....	6
1.5	Meaning of symbols	6
1.6	Target group.....	8
1.7	Warranty and Liability.....	8
1.8	Environmental protection.....	9
2	Safety	
2.1	General safety information.....	11
2.2	Authorized persons for device access.....	11
2.3	Safety instructions for cleaning operation.....	11
2.4	Accident prevention regulations.....	13
2.5	Lifting and moving loads.....	13
2.6	Periodic inspections.....	13
2.7	Operator obligations.....	13
2.8	Manufacturer tests and certificates	13
2.9	Guidelines for liquid sprayers	14
2.10	Design changes to the device.....	14
2.11	Safety devices.....	14
3	Product information	
3.1	Device views Series KS / Serie KS-INOX.....	15
3.2	Hinged device cover opened	16
3.3	Type plates	17
3.4	Serial number	18
3.5	Technical data.....	18
3.5.1	Series KS with Chassis-Version Basic and INOX	18
3.5.2	Series KS-UK with Chassis-Version Basic and INOX	19
4	Device assembly	
4.1	Scope of delivery for Series KS.....	22
4.2	General information on device assembly	23
4.3	Selection of the operating site.....	24
4.4	Device assembly	24
4.4.1	Establishing the water connection	25
4.4.2	Assembly of the wash place equipment	25
4.4.3	Electrical connection.....	26
5	Commisioning	
5.1	Commisioning the device.....	28

6	Operation	
6.1	Control and indicator elements of the device.....	29
6.2	Control elements of the trigger gun.....	30
6.3	EMERGENCY STOP switch-off in case of danger.....	30
6.4	Cleaning operation... vor Heißwasserbetrieb warnen.....	31
6.4.1	Operation without cleaning detergent.....	31
6.4.2	Operation with cleaning detergent (chemistry).....	33
7	Decommissioning	
7.1	Temporary decommissioning.....	36
7.2	Decommissioning for a longer period of time.....	37
8	Maintenance	
8.1	General Information.....	38
8.2	EHRLE Maintenance and Inspection Contract.....	38
8.3	Maintenance work.....	38
8.3.1	Frost Protection.....	40
8.3.1.1	Drain water from high pressure cleaner.....	40
8.3.1.2	Rinse high pressure cleaner with antifreeze agent.....	40
8.3.2	Filter in the water inlet.....	40
8.3.3	Checking the HP-Hoses.....	41
8.3.4	Oil change.....	41
9	Troubleshooting	
9.1	Troubleshooting table.....	42

1 User information

1.1 General



General Information

For a comprehensive advice and information on the Stationary Coldwater High Pressure Cleaners of the Series KS please contact the EHRLE Customer Service.

With the purchase of a EHRLE Stationary Coldwater High Pressure Cleaner you are the owner of a quality product, which is characterised by:

- user-friendliness,
- reliability,
- environmental friendliness.

These Installation and Operating Instruction are part of the Stationary Coldwater High Pressure Cleaner and must be kept at the operating site and available at all times.

For the Stationary Coldwater High Pressure Cleaner of Series KS, the manual contains information on

- User information
- Safety
- Product information
- Device assembly
- Commissioning, Decommissioning
- Operation
- Maintenance
- Troubleshooting.

The German Installation and Operating Instruction are the original version.

1.2 Functional device concept

Due to the specific constructive properties the high pressure cleaners can be used in a variety of ways in all conceivable industries depending on type, for example:

- Industry
- Agriculture and forestry
- Food industry (stainless steel version)
- Construction company (vehicle fleet, working machines)
- Forwarding companies, vehicle and rental parks
- Local government
- Hotels and restaurants, as well as food industry.

1.3 Terminology

In this manual the terminology listed below is replaced by the relevant short terms whenever possible

- Stationary Coldwater High Pressure Cleaner of the Series KS high pressure cleaner or device
- Installation and Operating Instruction manual
- High pressure hose HP-Hose

If a clear reference to a subject is required in the description parts, the terminology „Stationary Coldwater High Pressure Cleaner of the Series KS“ is used.

1.4 Meaning of the emphasis

The emphasis used in this manual have the following meanings:

WARNING

Warning precedes operating procedures, instructions, etc., which, if not strictly observed, could result in personal injury or loss of life. Warning precedes also, when device misuse could result in personal injury or loss of life.



CAUTION







Caution precedes operating procedures, instructions, etc., which, if not strictly observed, could result in damage to the high pressure cleaner. Caution precedes also, when device misuse could result in damage to the high pressure cleaner.







This symbol indicates additional information.

1.5 Meaning of symbols

Symbol	Meaning
	<p>WARNING Follow instructions!</p> <p>Non-observance or neglecting of prescribed instructions, incorrect operation or misuse of the device may endanger life and limb of persons.</p>
	<p>WARNING Danger of death due to electric shock.</p> <p>Do not open the device. During operation, dangerous voltages are present on live parts of the device. Touching live parts can lead to life-threatening injuries.</p>

Symbol	Meaning
	<p>WARNING Danger of burns and scalds.</p> <p>When operating with a water temperature of up to 80 °C, the cleaning objects, the hot water emerging from the trigger gun or device components can become hot.</p> <p>Touching hot surfaces or hot water can cause burns or scalding of the skin surface.</p> <p>Make sure that the surfaces have cooled down before touching them.</p> <p>The hot water coming out of the trigger gun must not come into contact with the skin.</p>
	<p>WARNING Explosion hazard due to use of unauthorised cleaning agents.</p> <p>Never aspirate liquids containing solvents such as paint thinners, petrol, oil or similar liquids.</p> <p>The spray mist of solvents is highly flammable, explosive and toxic.</p> <p>Follow the instructions of the additive manufacturer!</p>
	<p>WARNING Danger with heavy loads.</p> <p>A person is not allowed to lift and move loads more than 23 kg.</p> <p>Otherwise the health of persons may be endangered (e.g. overload of the spinal column, injuries from falling loads).</p> <p>For loads of more than 23 kg, use suitable lifting equipment (e.g. forklift truck, lift truck).</p>
	<p>CAUTION Observe instructions for installation, device adjustment, operation, maintenance and repair.</p> <p>Non-observance or neglecting prescribed instructions, incorrect operation or misuse of the device may result in damage to device parts, assemblies or components.</p>
	<p>General Information General additional information.</p>
	<p>Information on recycling General information on recycling.</p>

Symbol	Meaning
	<p>Information on disposal</p> <p>General information on the professional and environmentally sound disposal of old appliances, assemblies, components, materials and consumables.</p> <p>The symbol with the crossed-out dustbin indicates that.</p>
	<p>Information on hearing protection</p> <p>General information on hearing protection.</p>
	Requires direct action.
	Result after an action.
	Itemisation

1.6 Target group

These Installation and Operating Instruction contain information and instructions for

- authorised, instructed and trained operating personnel for carrying out cleaning work
- authorised, qualified and trained personnel for the installation, operation, maintenance, repair and adjustment of the device.

1.7 Warranty and Liability

The EHRLE Stationary Coldwater High Pressure Cleaner of Series KS may only be used for its intended purpose.

Intended use includes:

- Operation only by authorised persons who
 - are instructed and trained on the device, or
 - have completely read and understood the information and instructions in these Installation and Operating Instruction and can therefore guarantee safe handling of the device.
- The information and instructions contained in this Manual must be observed.
- If the safety and protective devices are faulty, the high pressure cleaner must not be put into operation.

- The high pressure cleaner may only be operated with fully functional safety and protective devices. In the event of functional failures during operation, the high pressure cleaner must be taken out of operation immediately.
- Faulty, insufficient or defective high pressure cleaners must not be put into operation. Before commissioning, carry out a visual inspection for faulty or defective
 - device parts, assemblies or components
 - electrical cables
 - HP-Hoses.
- The high pressure cleaner must be switched off immediately and taken out of operation if defects, faults or deficiencies occur on
 - device parts, assemblies or components
 - electrical cables
 - HP-Hoses.
- No constructive changes may be made to the device.
- The device may only be operated in the configuration certified by the manufacturer. Operation with subsequently installed modules, components or additional devices is not permitted and may endanger life and limb of persons or lead to damage to the device.
- Only original parts from the manufacturer or consumables approved by the manufacturer may be used for maintenance and repair work.

Any warranty and liability claims for personal injury and damage to the device are void if the high pressure cleaner is not used for its intended purpose.

1.8 Environmental protection



Note on recycling

The packaging materials are recyclable. Please do not throw the packaging into the household waste, but recycle it.



Note on disposal

Old appliances, assemblies or parts contain valuable recyclable materials that should be sent for possible recovery.

The old appliances must not be disposed of together with unsorted municipal waste (household waste). The symbol with the crossed-out dustbin on the appliance indicates this obligation.

Therefore, please dispose of discarded devices, assemblies or parts properly via suitable collection systems.

Dispose of used materials in an appropriate and environmentally friendly manner. Observe the local regulations.

Old appliances contain valuable recyclable materials that should be recycled.

According to environmental regulations, waste water containing mineral oil, fuels for hot water heating or lubricants such as oils and greases must not enter the soil, water or sewerage system. Dispose of these substances properly.

Do not allow engine oil, fuel oil or petrol to escape into the environment. Protect the soil and dispose of used oil in an environmentally friendly manner.

Engine cleaning or underbody washing of all types of vehicles may only be carried out at washing stations equipped with oil separators in accordance with environmental regulations (environmental protection).

2 Safety

2.1 General safety information

Observe the respective national regulations of the legislator for liquid sprayers.

Observe the relevant national regulations of the legislator on accident prevention. Liquid sprayers must be inspected regularly and the result of the inspection must be recorded in writing.

Observe the safety data sheets and instructions of the cleaning agent manufacturers supplied with the detergents used.

Keep cleaning agents out of the reach of unauthorized persons. Risk of poisoning or caustic burns from cleaning agents! Observe the instructions on the cleaning agents.

Perform prescribed maintenance and inspection work in due time (see Section 8, Maintenance).

Safety-relevant defects must be rectified immediately.

Observe all warning and information signs attached to the unit. Keep all signs on the device legible.

2.2 Authorized persons for device access

Ensure that access to the device is only possible for the persons who

- have completely read and understood the information and instructions in this Installation and Operating Instruction and can therefore guarantee safe handling of the device or
- are instructed and trained on the device.

Children as well as persons with reduced physical, sensory or mental abilities are not allowed to operate the device.

2.3 Safety instructions for cleaning operation

During cleaning work, the personnel at the workplace must wear the necessary Personal Protective Equipment (PPE). This includes waterproof protective suits, rubber boots, protective goggles, headgear, ear protection if necessary, etc.

No cleaning work may be carried out in the presence of persons without sufficient PPE.

Before switching on, carry out a visual inspection of the device parts from the outside for damage (HP-Hose, electrical or mechanical parts). Devices with damaged parts, assemblies or components must not be put into operation.

The water jet leaving the trigger gun must not be directed at

- persons
- animals
- live electrical installations (building mains connections, sockets, electrical wiring, etc.)
- live electrical installations, machines, devices, assemblies or components
- system, machinery or equipment in operation.

Under the influence of the high pressure jet, parts can be separated from the cleaning object and thrown away. Persons can be injured as a result.

Never aim the high pressure jet at fragile or loose objects.

When cleaning tyres and their valves, keep a minimum distance of 30 cm from the high pressure nozzle. Otherwise damage may occur.

Before cleaning the high pressure cleaner itself, take the device out of operation and disconnect it from the electrical mains connection. Secure the device against unintentional or unauthorised restarting (e.g. lock main switch, disconnect mains cable from power outlet, provide warning sign indicating work on the high pressure cleaner, etc.).

Never operate the device unattended.

The device is designed for a water inlet temperature of up to 80 °C. When operated with hot water, water-carrying parts (for example pump housing, uninsulated pipes, metal parts of the trigger gun and spray lance) as well as cleaning objects may become hot. Touching hot surfaces can cause burns or scalding of the skin surface. Make sure that the surfaces have cooled down before touching them.

The hot water escaping from the trigger gun must not come into contact with the skin. After hot water operation, wait until the water has cooled down again.

Asbestos-containing and other materials containing substances hazardous to health must not be sprayed off.



Information on hearing protection.

If the sound levels exceed the permissible values, the personnel and persons in the area of exposure must wear hearing protection.

The sound level for EHRLE high pressure cleaners under maximum load is 82 dB (A). A high sound level over a long period can cause hearing loss. If the noise produced by the application of the emerging high pressure jet to noise-enhancing objects exceeds the permissible values, the operating personnel and any persons affected must wear hearing protection.

Do not operate the device if electrical cables or other safety-relevant parts (pressure relief valve, HP-Hose, trigger gun, etc.) are defective.

Before changing the cleaning agent, flush out the complete high pressure system for minimum 30 s by pulled trigger gun. This avoids subsequent dangerous chemical reactions.

The Stationary Coldwater High Pressure Cleaners are not to be used in

- rooms with flammable or explosiveness atmosphere
- gas-stations or other hazardous areas.

Aerosols can be formed when using high pressure cleaners. An aerosol is a mixture of solid or liquid suspended particles in a gas. Inhaling aerosols can be harmful for your health.

Employers are obliged to perform a hazard assessment in order to define, depending on the surface to be cleaned and the environment, protective measures necessary to prevent inhalation of aerosols.

Respiratory protection masks of class FFP 2 or above are suitable for protection against aqueous aerosols.

Using the device for longer periods can cause poor circulation in the hands due to vibrations. A general period of use cannot be set, because this depends on several influencing factors:

- Personal tendency to suffer from poor circulation (frequently cold fingers, tingling sensation in the fingers)
- Low ambient temperature. Wear warm gloves to protect your hands.
- Holding the device too tightly hindering blood circulation.
- Continuous operation is more harmful than operation interrupted by work breaks.

You should see a doctor if using the device regularly and for lengthy periods of time, and in the event of repeated occurrences of symptoms such as tingling in the fingers or cold fingers.

Observe the local regulations on the installation and operation of the high pressure cleaners.

The HP-hose do not

- run over, pull excessively or twist
- pull over sharp edges
- repair.

Replace the defective HP-hose with an HP-hose approved by the manufacturer.

2.4 Accident prevention regulations

Observe the applicable national regulations of the legislator on accident prevention.

2.5 Lifting and moving loads

The Stationary Coldwater High Pressure Cleaners weigh from 110 kg to 120 kg depending on the type (with packaging from approx. 120 kg to approx. 135 kg).

Lifting and moving loads is permitted for one person up to 23 kg. If the load exceeds 23 kg use suitable lifting equipment (e.g. forklift, lift trucks).

Observe the international standard „ISO 11228-1 Ergonomie - Manuelles Handhaben von Lasten - Teil 1 Heben und Tragen 05/2003“.

2.6 Periodic inspections

The periodic inspections are listed in Section 8 (Maintenance).

2.7 Operator obligations

The operator must ensure that before each commissioning of the liquid sprayer, its safety-relevant parts are checked for their perfect condition (safety relief valves, HP-Hoses, trigger gun, electrical cable, etc.).

2.8 Manufacturer tests and certificates

Before delivery the high pressure cleaner passed the high pressure cleaner factory test. The scope of delivery encloses the factory test protocol.

2.9 Guidelines for liquid sprayers

High pressure cleaners must be inspected by an expert in accordance with the „Guidelines for liquid sprayers“, if necessary or at least every 12 months. The result of the test must be recorded in writing.

In the appendix of this manual there is a test sheet (proof of customer service) to record the tests carried out.

EHRLE service technicians are experts and can be consulted and commissioned by EHRLE service for this prescribed inspection.

2.10 Design changes to the device

Design changes to the high pressure cleaner are not permitted.

Inadmissibly constructively modified devices can endanger the life and limb of persons.

When operating a device which has been modified or changed in design, the device will not be used for its intended purpose. If the device is not used for its intended purpose, no liability or warranty will be accepted (see Section 1.7, Warranty and Liability).

2.11 Safety devices

Safety devices serve to protect the user and must not be suspended or circumvented in their function.

The high pressure cleaner has the following safety devices listed below:

- Pressure switches:
Device functions are switched on or off (safety functions) based on type of construction and intended use.
- Unloader valve and non-return valve:
The first serves to adjust the operating pressure and the second valve keeps the pump head depressurised when the trigger gun is deactivated.
- TSS system with pump-off delay:
After deactivating the trigger gun, the pump continues operation for approx. 30 s in the pressureless bypass mode (avoidance of too high pressure build-up in the pump); then the motor is switched off.
- Total Switch-off:
Automatically switches the high pressure cleaner off in the event of prolonged interruption of operation or unused trigger gun for more than 20 minutes.
- Overload protection switch:
When the motor current load is too high the switch releases and the device is switched off.
- Mechanical arrest for trigger gun:
Prevents unintentional or unconscious activating the trigger gun.
- Thermostat maximum:
Triggers if pump temperature is too high. If the permissible pump temperature is exceeded, the device is switched off.

3 Product information

3.1 Device views Series KS / Serie KS-INOX

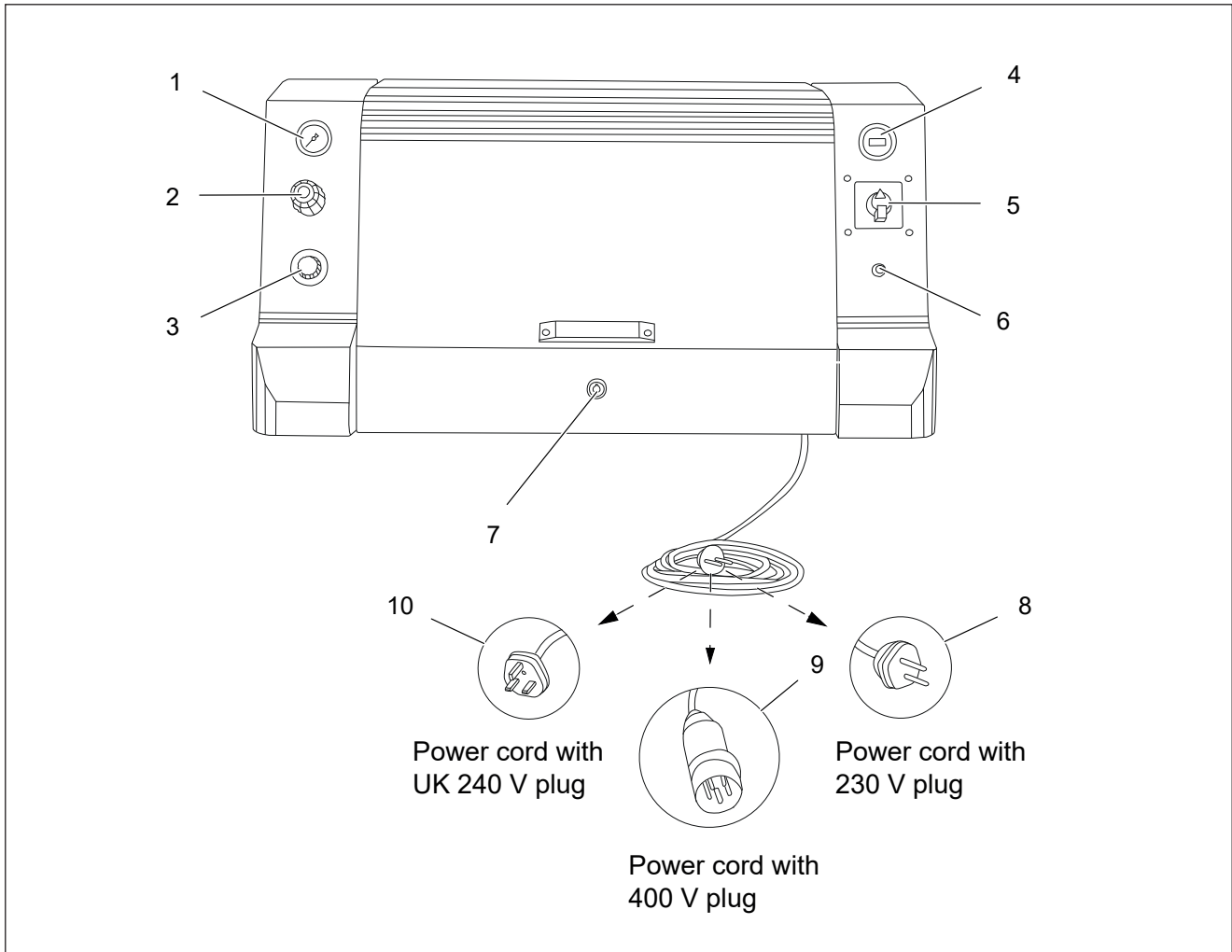

- | | |
|---|--|
| <ul style="list-style-type: none"> 1 Pressure gauge for operating pressure indication with running HP pump and trigger gun activated 2 Unloader valve 3 Detergent control valve 4 Service hour meter 5 Device switch 0/1 | <ul style="list-style-type: none"> 6 Thermostat Maximum (device shutdown if pump temperature is to high) 7 Lock 8 Power cord with 230 V plug (KS823-B) 9 Power cord with plug 400 V plug (KS1140-B) 10 Power cord with UK 240 V plug (KS823-UK-B) |
|---|--|

Fig. 3 - 1 Series KS, front view

3.2 Hinged device cover opened

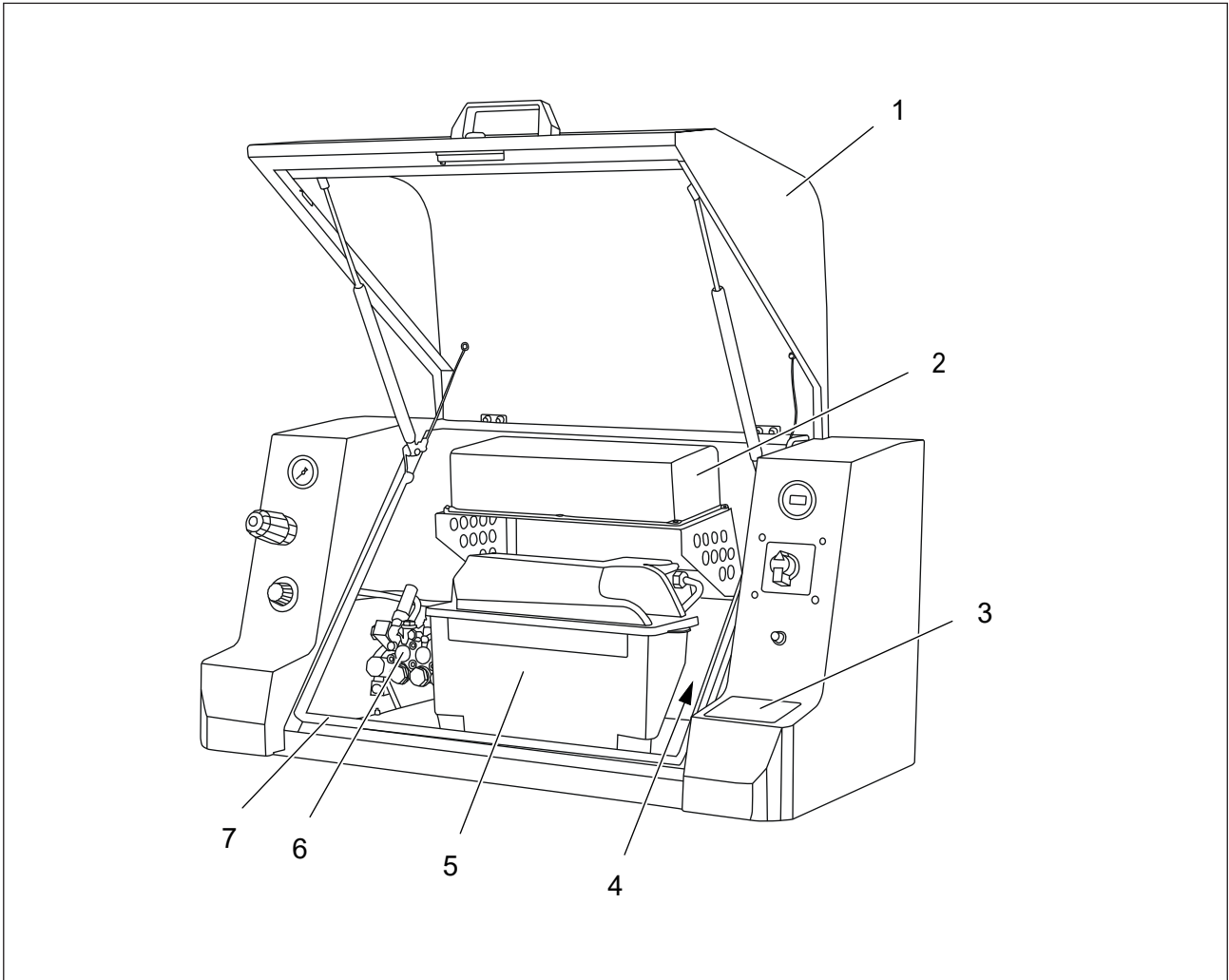

- | | | | |
|---|-------------------------|---|-----------------------|
| 1 | Hinged device cover | 5 | Float container |
| 2 | Electronic control unit | 6 | High pressure pump |
| 3 | Warning label | 7 | Circumferential seal |
| 4 | Motor with gear box | | (hinged device cover) |

Fig. 3 - 2 Series KS, hinged device cover opened

3.3 Type plates

KS823-B

Type: KS823
157-XX-B



Voltage	1/N/PE/AC/50Hz/230V
Operating pressure	30-120bar/ 3-12MPa
Max. pressure	140bar/ 14MPa
Discharge capacity	300 - 720l/h
Nozzle size	050
Max. Inlet temp.	80°C
Pump speed	1400rpm
Connected load	2,6kW / 12,8A
Electrical protection	16A slow



Serial No.: 00111011087204

EHRLE GmbH | Industriestraße 3 D-89165 Dietenheim
 Tel.: 0 73 03 / 16 00-0 | Fax: 0 73 03 / 16 00-600

KS1140-B

Type: KS1140
155-XX-B



Voltage	3/PE/AC/50Hz/400V
Operating pressure	30-180bar / 3-18MPa
Max. pressure	200bar / 20MPa
Discharge capacity	300 - 1.000l/h
Nozzle size	055
Max. Inlet temp.	80°C
Pump speed	1400rpm
Connected load	6,5kW / 10,5A
Electrical protection	3x16A slow



Serial No.: 11001011087204

EHRLE GmbH | Industriestraße 3 D-89165 Dietenheim
 Tel.: 0 73 03 / 16 00-0 | Fax: 0 73 03 / 16 00-600

KS823-UK-B

Type: KS823 UK
157001-XX-B



Voltage	1/N/PE/AC/50Hz/240V
Operating pressure	30-120bar/ 3-12MPa
Max. pressure	140bar/ 14MPa
Discharge capacity	300 - 720l/h
Nozzle size	050
Max. Inlet temp.	80°C
Pump speed	1400rpm
Connected load	2,2kW / 12,8A
Electrical protection	13A slow



Serial No.: 10001011087204

EHRLE GmbH | Industriestraße 3 D-89165 Dietenheim
 Tel.: 0 73 03 / 16 00-0 | Fax: 0 73 03 / 16 00-600

KS823-UK-INOX-B

Type: KS823 UK-INOX
157002-XX-B



Voltage	1/N/PE/AC/50Hz/240V
Operating pressure	30-120bar/ 3-12MPa
Max. pressure	140bar/ 14MPa
Discharge capacity	300 - 720l/h
Nozzle size	050
Max. Inlet temp.	80°C
Pump speed	1400rpm
Connected load	2,2kW / 12,8A
Electrical protection	13A slow



Serial No.: 10001011087204

EHRLE GmbH | Industriestraße 3 D-89165 Dietenheim
 Tel.: 0 73 03 / 16 00-0 | Fax: 0 73 03 / 16 00-600

KS823-INOX-B

Type: KS823-INOX
157000-XX-B



Voltage	1/N/PE/AC/50Hz/230V
Operating pressure	30-120bar/ 3-12MPa
Max. pressure	140bar/ 14MPa
Discharge capacity	300 - 720l/h
Nozzle size	050
Max. Inlet temp.	80°C
Pump speed	1400rpm
Connected load	2,6kW / 12,8A
Electrical protection	16A slow



Serial No.: 00111011087204

EHRLE GmbH | Industriestraße 3 D-89165 Dietenheim
 Tel.: 0 73 03 / 16 00-0 | Fax: 0 73 03 / 16 00-600

KS1140-INOX-B

Type: KS1140-INOX
155000-XX-B



Voltage	3/N/PE/AC/50Hz/400V
Operating pressure	30-180bar / 3-18MPa
Max. pressure	200bar / 20MPa
Discharge capacity	300 - 1.000l/h
Nozzle size	055
Max. Inlet temp.	80°C
Pump speed	1400rpm
Connected load	6,5kW / 10,5A
Electrical protection	3x16A slow



Serial No.: 10111011087204

EHRLE GmbH | Industriestraße 3 D-89165 Dietenheim
 Tel.: 0 73 03 / 16 00-0 | Fax: 0 73 03 / 16 00-600

3.4 Serial number

The serial number on the type plate uniquely identifies the product. It is required for the Ehrle customer service.

3.5 Technical data

3.5.1 Series KS with Chassis-Version Basic and INOX

		Device-Chassis Basic and INOX	
		KS823-B	KS1140-B
Electricals connection			
Mains voltage	V	230	400 - 415
Phase	~	1	3
Mains frequency	Hz	50	50
Connected load	kW	2,6	6,5
Current (max.)	A	12,8	10,5
Degree of protection	IP	IPX5	IPX5
Main fuse (slow-blowing)	A	16	3 x 16
Residual current circuit breaker (max. allowed residual current)	mA	30	30
Water connection			
Max. feed pressure (max.)	bar	5	5
	MPA	0,5	0,5
Max. feed temperature (max.)	°C	80	80
Feed volume	l/min	12	16
Suction height	m	0	0
Performance data device			
Nozzle size	---	050	055
Operating pressure	bar	30 - 120	30 - 180
	MPA	3 - 12	3 - 18
Max. operating over-pressure	bar	140	200
	MPA	14	20

Tab. 3 - 1 Technical data for Stationary Coldwater High Pressure Cleaners Series KS

		Device-Chassis Basic and INOX	
		KS823-B	KS1140-B
Discharge capacity	l/h	300 - 720	300 - 1000
Recoil force trigger gun	N	34,5	55,4
Pump speed	U/min	1400	1400
Dimensions and weights			
Weight (with packaging)	kg	110 (125)	120 (135)
Length (with packaging)	mm	1020 (1190)	1020 (1190)
Width (with packaging)	mm	500 (880)	500 (880)
Height (with packaging)	mm	500 (1270)	500 (1270)
Lubricant			
Amount of oil	l	0,45	0,65
Oil grade	Type	5W30	5W30

Tab. 3 - 1 Technical data for Stationary Coldwater High Pressure Cleaners Series KS

3.5.2 Series KS-UK with Chassis-Version Basic and INOX

		Device-Chassis Basic and INOX	
		KS823-UK-B	
Electricals connection			
Mains voltage	V	240	
Phase	~	1	
Mains frequency	Hz	50	
Connected load	kW	2,2	
Current (max.)	A	12,8	

Tab. 3 - 2 Technical data for Stationary Coldwater High Pressure Cleaners - Series KS-UK

**Device-Chassis
 Basic and INOX**

KS823-UK-B

Degree of protection	IP	IPX5
Main fuse (slow-blowing)	A	13
Residual current circuit breaker (max. allowed residual current)	mA	30
Water connection		
Max. feed pressure (max.)	bar	5
	MPA	0,5
Max. feed temperature (max.)	° C	80
Feed volume	l/min	12
Suction height	m	0
Performance data device		
Nozzle size	---	050
Operating pressure	bar	30 - 120
	MPA	3 - 12
Max. operating over-pressure	bar	140
	MPA	14
Discharge capacity	l/h	300 - 720
Recoil force trigger gun	N	34,5
Pump speed	U/min	1400
Dimensions and weights		
Weight (with packaging)	kg	110 (125)
Length (with packaging)	mm	1020 (1190)
Width (with packaging)	mm	500 (880)
Height (with packaging)	mm	500 (1270)
Lubricant		
Amount of oil	l	0,45
Oil grade	Type	5W30

Tab. 3 - 2 Technical data for Stationary Coldwater High Pressure Cleaners - Series KS-UK

4 Device assembly



WARNING

Ensure correct device assembly.

The persons assembling the high pressure cleaners must have

- read this manual and understood, that error-free device assembly can be guaranteed, or
- specially trained and instructed on the respective device.

Otherwise, the life and limb of persons may be endangered.



WARNING

Danger with heavy loads.

The Stationary Coldwater High Pressure Cleaners of the Series KS weigh from 110 kg to 120 kg depending on the type (with packaging from approx. 125 kg to approx. 135 kg).

A person is not allowed to lift and move loads (e.g. devices, assemblies) more than 23 kg.

Otherwise the health of persons may be endangered (e.g. overload of the spinal column, injuries from falling loads).

For loads of more than 23 kg, use suitable lifting equipment (e.g. forklift, lift truck).



General Information

For detailed advice and information on the device assembly please contact the EHRLE customer service.

On receipt of the delivery, check the packaging for transport damage.

Check the contents of the delivery for completeness and damage. Check for oil leakage.

In the event of incomplete delivery or defects, consult the EHRLE customer service immediately.



Note on recycling

The packaging materials are recyclable. Please do not throw the packaging into the household waste, but recycle it.

4.1 Scope of delivery for Series KS



 <p>Series KS823-B / KS823-B-UK Series KS1140-B</p>		 <p>Series KS823-INOX-B / KS823-INOX-B-UK Series KS1140-INOX-B</p>	
 <p>Spray lance 900 mm with nozzle-protection*</p>	 <p>Trigger gun</p>	 <p>HP-Hose red, length 10 m</p>	 <p>Operating instruction, Safety Instructions</p>
<p>* Nozzle size: 050 for Series KS823 / KS823-UK 055 for Series KS1140</p>			

Fig. 4 - 1 Scope of delivery, Series KS

4.2 General information on device assembly

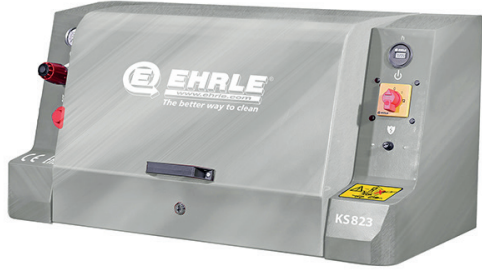

General Information

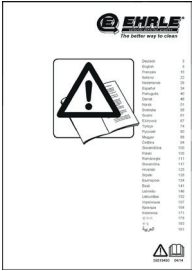
The following illustration shows a general example of the device installation for the basic configuration with associated accessories.

The EHRLE customer service offers comprehensive advice and information on the planning, design and installation of an extended system tailored to the individual customer's requirements.

EHRLE customer service can be consulted at any time about the wide range of possibilities for the various system expansion stages and extensions.

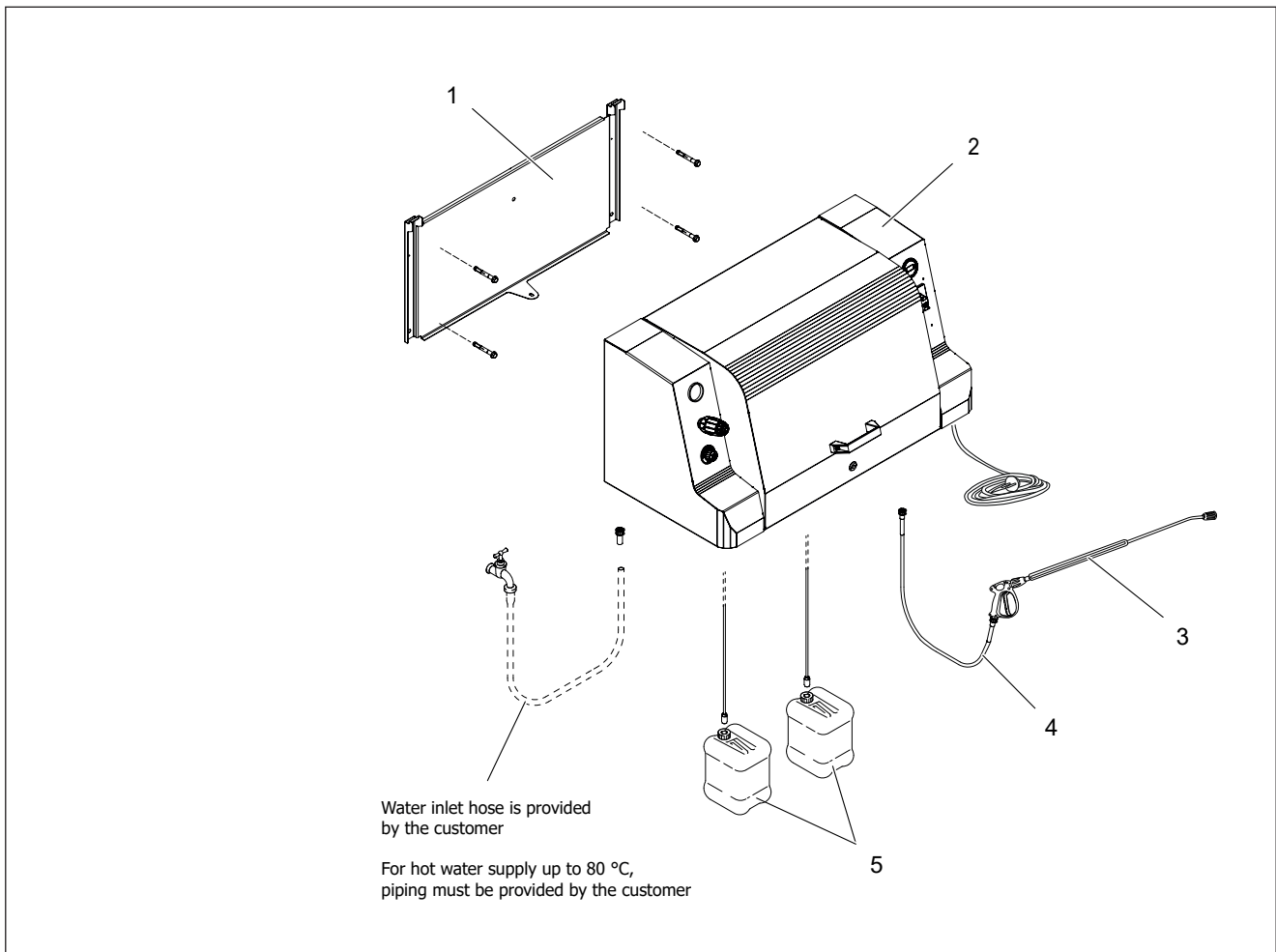

- | | | | |
|---|--|---|------------------------------|
| 1 | Wall bracket | 3 | Trigger gun with spray lance |
| 2 | Stationary Coldwater High Pressure Cleaner Series KS | 4 | HP-Hose |
| | | 5 | Detergent Container |

Fig. 4 - 2 Device assembly, general example with cable connection 230 V

4.3 Selection of the operating site



WARNING

Observe safety regulations.

The local regulations concerning the device assembly and operation of the high pressurer cleaners must be observed.

The Stationary Coldwater High Pressure Cleaners of Series KS must not be set up and operated in fire and explosion hazardous areas.

Otherwise, the life and limb of persons may be endangered.

When selecting the operating site, take into account

- load bearing wall for device assembly
- suitable washing area with water drainage
- mains connection for power supply cable
- building connection for water supply line with 3/4 inch shut-off valve
- space required for trigger gun and spray lance as well as for HP-hose
- space required for cleaning objects
- supply voltage and water supply must be designed for continuous operation and guarantee the specifications in the technical data (see section 3.5)
- frost-free operating location.

4.4 Device assembly



WARNING

Carry out all assembly work professionally.

The personnel assembling the high pressure cleaners must

- be qualified, specially trained and authorized
- have read this manual and understood, that error-free device assembly can be guaranteed.

Otherwise, the life and limb of persons may be endangered.

The manufacturer recommends fixing the wall bracket to solid concrete walls with suitable heavy-duty dowels. Before device assembly the load bearing capacity of the wall should be checked.

For fixing the wall bracket, see the general example (Fig. 4-2).

4.4.1 Establishing the water connection

The building water connection (tap water network) for the water supply of the high pressure cleaner must be designed for trouble-free constant operation (see Section 3.5, Technical Data).

The design of the water connection to the drinking water network must meet the requirements according to DIN 1988 (Drinking water pipe systems in properties, technical regulations for construction and operation). Country-specific guidelines and regulations must be observed.

The regulations of the relevant water supply company must be observed! According to EN 61 770, the high pressure cleaner must not be directly connected to the public drinking water supply. However, according to DVGW (Deutscher Verband des Gas- und Wasserfaches - German Gas and Water Association), short-term connection is permissible if a backflow preventer with a pipe ventilator is installed in the supply line.

Water after the backflow preventer is no longer considered drinking water.

An indirect connection to the public drinking water supply is also permissible by means of a free outlet. The water supply must comply with EN 61 770, e.g. by using a tank with a float valve. Direct connection to a pipe network not intended for drinking water supply is permissible.

The water connection of the tap water network has to be equipped with a shut-off valve. The water supply capacity for the device must ensure a minimum of 1200 l/h by a hydraulic pressure between 1 bar and 6 bar.

Connect the water supply of the infrastructure (e.g. building water connection) equipped with a shut-off valve to the high-pressure cleaner via a flexible pressure hose (provided by the customer) with at least 1/2 inch (see Fig. 4-2).

The water inlet temperature to the device may be max. 80 °C.

For a hot water inlet of up to 80 °C, the customer must use appropriately dimensioned hot water-resistant piping with a shut-off valve.

The environmental, waste and water protection regulations must be observed by the system operator!

4.4.2 Assembly of the wash place equipment

A general example of a plant with wash place equipment shows the Fig. 4-2.

For the assembly of the wash place equipment (see also Fig. 4-1, accessories):

- Connect the trigger gun to the spray lance.
- Screw the high pressure nozzle into the spray lance. The device specific high pressure nozzle is listed in the following table.
- Connect the HP-hose (Fig. 4-2) to the trigger gun and to the device.

Only original EHRLE HP-hoses may be used. The EHRLE HP-hoses can be identified by the kink protection and comply with the requirements of the „Guidelines for liquid sprayers“.

Device	High pressure nozzle
KS823-B	050
KS1140-B	055
KS823-UK-B	050
KS823-UK-INOX-B	050
KS823-INOX-B	050
KS1140-INOX-B	055

Tab. 4 - 1 High pressure nozzle size

4.4.3 Electrical connection



WARNING

Ensure proper mains connection.

The electrical connection may only be carried out by qualified and specially trained personnel.

Only connect the system to voltage sources earthed in accordance with the safety regulations (e.g. mains connection of buildings).

All live parts in the intended working area for cleaning work, e.g. equipment, cables, sockets etc., must be protected against water jets in accordance with safety regulations.

The electrical mains connection (e.g. building connection) must, depending on the device, be in accordance with the technical data (see section 3.5), and

- correspond to the electrical values indicated on the type plate of the device and therefore
- ensure trouble-free constant operation.

The mains connection of the infrastructure must be equipped with a residual current circuit breaker 30 mA (on-site customer provision).

All live parts, cables and equipment in the working area must be in perfect condition and protected against water jets.

The following table shows the requirements for the mains connection from the building (or infrastructure).

Device	Voltage	Fuse (slow-blowing)
KS823-B	230 VAC	16 A
KS1140-B	400 VAC	3 x 16 A
KS823-UK-B	240 VAC	13 A
KS823-UK-INOX-B	240 VAC	13 A
KS823-INOX-B	230 VAC	16 A
KS1140-INOX-B	400 VAC	3 x 16 A

Tab. 4 - 2 Required voltage supply (building connection)

5 Commissioning

5.1 Commissioning the device



WARNING

Commissioning must be carried out professional.

The commissioning of the high pressure cleaners may only be carried out by authorised personnel which

- have completely read and understood the information and instructions in this Installation and Operating Instruction
- are instructed and trained on the device.

Otherwise the life and limb of persons may be endangered.

The EHRLE high pressure cleaners are subjected to a final test for correct function and safety before delivery.

The first commissioning and the first cleaning operation serve to check the correct functioning of the device, if damage to components that is not immediately visible during transport has occurred.

If the device functions incorrectly, consult the EHRLE customer service immediately.

To commission the device, proceed as follows:

- ▶ If necessary, set the device switch 0/1 (5, Fig. 6-1) to the initial position 0.
- ▶ If necessary, set the detergent control valve (3, Fig. 6-1) to the initial position 0.
- ▶ Open the water supply from the tap water network via the shut-off valve (see Fig. 4-2).
For hot water inlet up to 80 °C, open the shut-off valve of the pipeline.
- ▶ Connect the power cord (see section 3, device views) to the mains connection (e.g. building connection).
- ▶ If necessary, switch on the main switch or circuit breaker of the mains connection (e.g. building connection) for the power supply of the device.
- ▶ To operate and perform cleaning work with the high pressure cleaner, proceed as given in Section 6 (Operation).

6 Operation

6.1 Control and indicator elements of the device

The control and indicator elements are the same for all types of the Series KS.

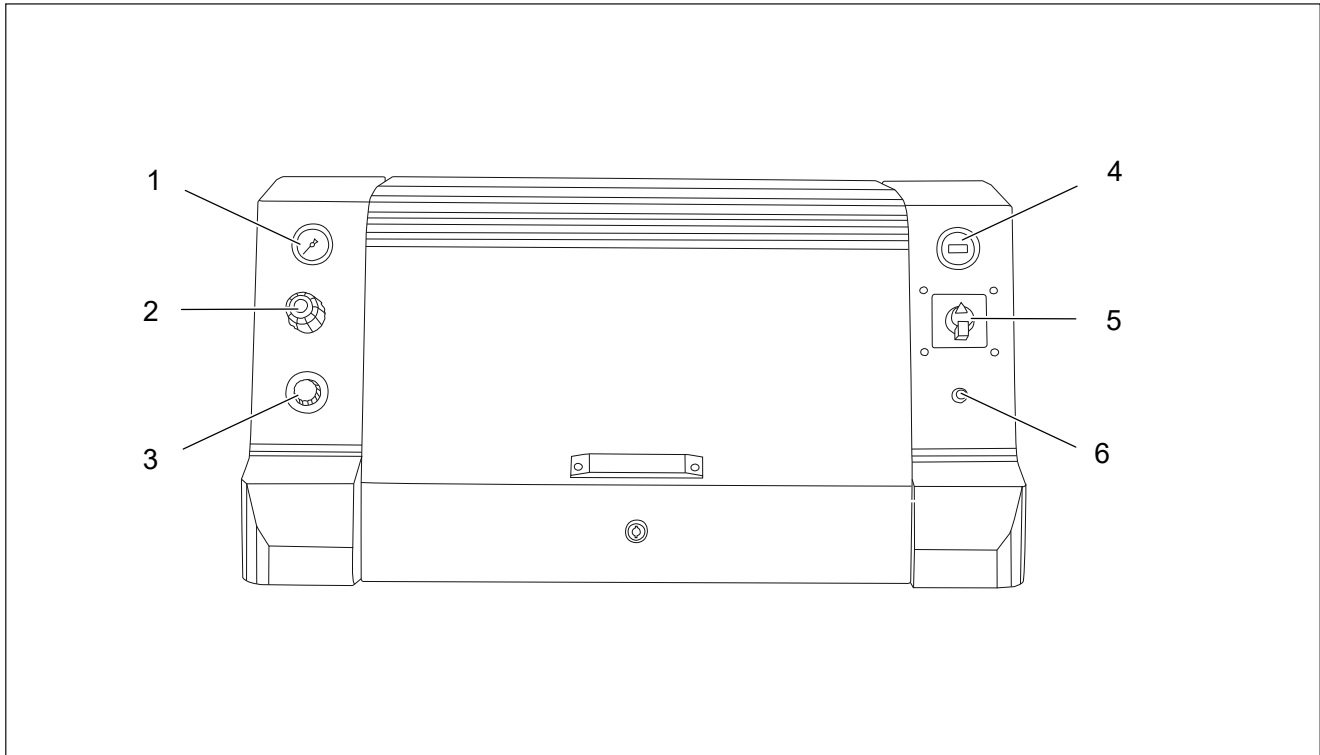

- | | | | |
|---|---|---|--|
| 1 | Pressure gauge for operating pressure indication with running HP pump and trigger gun activated | 4 | Service hour meter |
| 2 | Unloader valve | 5 | Device switch 0/1 |
| 3 | Detergent control valve | 6 | Thermostat Maximum (device shutdown if pump temperature is too high) |

Fig. 6 - 1 Control and indicator elements of Series KS

6.2 Control elements of the trigger gun

The following figure shows the control elements of the trigger gun.

To assemble (disassemble) the spray lance to the (from the) trigger gun see arrows in the following figure.

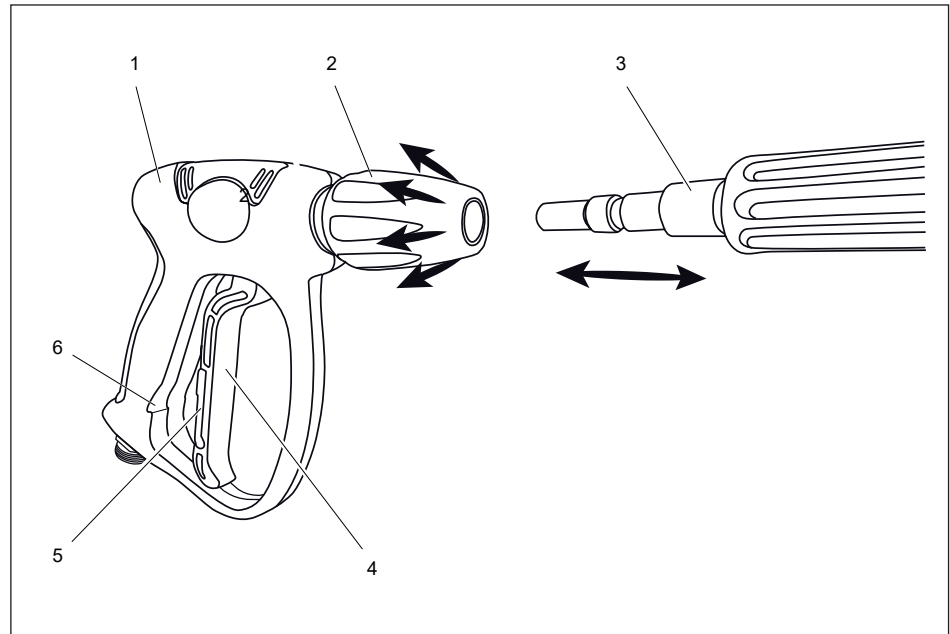

- | | | | |
|---|---------------|---|--|
| 1 | Trigger gun | 5 | Locking lever
(safety device) |
| 2 | Quick lock | 6 | Notch for locking lever
(arresting) |
| 3 | Spray lance | | |
| 4 | Trigger lever | | |

Fig. 6 - 2 Control elements of trigger gun

6.3 EMERGENCY STOP switch-off in case of danger



WARNING

In case of electrical accidents, never directly touch persons exposed life-threatening voltages..

In case of accidents with persons under life-threatening voltages, immediately switch off the supply voltage of the high-pressure cleaner or disconnect the power supply cable from the mains plug of the infrastructure. If possible, switch off the mains switch or circuit breaker for the mains voltage on the building connection.

Never touch the exposed person who has been involved in an accident directly. First aiders are also endangered by electric shock if they touch the person directly, in wet areas or over wet objects.

In extreme emergencies, without touching the injured person, use a dry garment, wooden slat or other insulating material to separate the person and mains voltage.

In case of accidents with persons or for accident prevention during device operation, perform an EMERGENCY STOP switch-off as follows:

- ▶ If necessary, if persons are still exposed to electric shock, switch off the mains voltage to the device via the circuit breaker (building connection) or disconnect the power supply cable from the mains socket.
- ▶ If necessary, set the device switch 0/1 (5, Fig. 6-1) to position 0.
- ▶ If necessary, activate the trigger gun (1, Fig. 6-2) until the high pressure cleaner is depressurised.
- ▶ If necessary, close the shut-off valve of the mains water supply.

6.4 Cleaning operation



WARNING

Electric shock hazard.

In the event of accidents (e.g. due to life-threatening voltages) involving persons or to prevent accidents, switch off the device (see Section 6.3, EMERGENCY STOP - Switch-off in case of danger).

The water jet emerging from the trigger gun must not be directed at live electrical components or devices (machines, devices, lines, sockets, etc.).

Before cleaning, disconnect the cleaning objects such as electrical devices, assemblies or components from the power supply.



WARNING

Ensure that the high pressure jet is used correctly.

The water jet coming out of the trigger gun must not be directed at persons or animals.

In the event of accidents (e.g. danger to persons, injured persons in the work area) or to prevent accidents, switch off the device (see Section 6.3, EMERGENCY STOP - Switch-off in case of danger).



CAUTION

Do not operate the device with contaminated or too hot water.

Operate the high pressure cleaner only with clear and unpolluted water.

The water inlet temperature to the device may be max. 80 °C.

Dirty or too hot water can damage the high pressure cleaner.

6.4.1 Operation without cleaning detergent

For carrying out cleaning work without the addition of cleaning detergent proceed as follows:

- ▶ Unlock and pull the trigger lever (4, Fig. 6-2) of the trigger gun.



WARNING

Before activating, hold the trigger gun and the spray lance tightly.

After activation of the trigger gun the emerging water jet exerts a jerky recoil force (see also Fig. 6-3).

This may result in unintentional jerking away from the selected cleaning object or the trigger gun slipping out of the hand, endangering the life and limb of persons

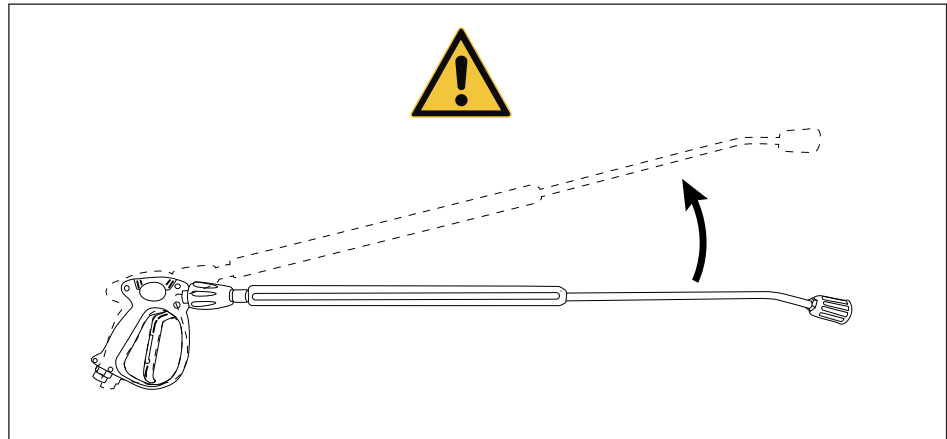

Fig. 6 - 3 Recoil force when switching on the trigger gun



WARNING

Danger of skin burns due to hot surfaces or scalding by hot water.

The device is designed for a hot water inlet up to 80 °C. During operation with hot water inlet, the surfaces of the high pressure cleaner (pump parts, metal parts of the spray lance, cleaning objects etc.) can become hot.

Touching hot surfaces or contact with hot water can cause skin burns or scalds. Avoid skin contact with hot water. Make sure that the device parts as well as the cleaning objects have cooled down before touching them.

- ▶ Set device switch 0/1 (5, Fig. 6-1) into position 1. The high pressure cleaner starts. The pump first delivers air from the high pressure nozzle. After a short time, water then escapes.
- ▶ With the trigger gun activated and the pump running, the desired working pressure can be set via the unloader valve (2, Fig. 6-1). By turning the unloader valve clockwise, the operating pressure increases - turning counterclockwise it decreases.
- ▶ The operating pressure can be read off the pressure gauge (1, Fig. 6-1) while the trigger gun is activated.
- ▶ If the trigger lever on the trigger gun is released, the high pressure cleaner switches to pressureless circulation operation. After approx. 30 sec. the device switches to stand-by mode. When the lever on the trigger gun is pulled again, the motor and the pump restart automatically.



General Information

If the device remains in stand-by mode for 20 minutes, the electronic control switches the high pressure cleaner off as programmed.

To resume operation, move the device switch 0/1 into position 0 and then back to operating position 1.

- ▶ For safety reasons after completion of cleaning work:
 - Switch off the device via the device switch 0/1 (into position 0)
 - Lock the trigger lever (4, Fig. 6-2) of the trigger gun against unintentional switching on using the locking lever (5, Fig. 6-2). Ensure that the locking lever is correctly arrested in the notch for locking lever (6, Fig. 6-2).
- ▶ If necessary, disconnect the power cord plug from the electrical mains socket.
- ▶ If necessary, close the shut-off valve of the mains water supply.

6.4.2 Operation with cleaning detergent (chemistry)



WARNING

Only use permitted detergents.

Only use cleaning detergents approved by the manufacturer EHRLE. The use of inadmissible detergents can endanger the operational safety of the device and thus the life and limb of persons.

There is a risk of poisoning or caustic burns with cleaning detergents. Avoid contact with skin surface and eyes. Observe the manufacturer's safety data sheets. Keep cleaning agents out of the reach of unauthorized persons.

Observe specifications for neutral additive pH value 7 ... 9. Observe the instructions of the additive manufacturer, e.g. Personal Protective Equipment (PPE), waste water regulations.



WARNING

Risk of explosion due to use of inadmissible detergents.

Never aspirate solvent-containing liquids such as paint thinners, petrol, oil or similar liquids. The spray of solvents is highly flammable, explosive and toxic.

Observe the specifications of the additive manufacturers!



CAUTION

Observe the safety data sheets for the detergent agents or chemical additives.

Follow the manufacturer's instructions for detergent agents or chemical additives in the safety data sheets.

Unsuitable and unapproved detergent agents can damage the device as well as the object to be cleaned.

The temperature specifications for the detergent agents and chemical additives must be observed during operation with hot water inlet.

Exceeding temperature limits of the detergent agents or chemical additives during operation with hot water inlet can cause damage to the high pressure cleaner.



CAUTION

Chemical dry run or inadmissible detergents can damage the high pressure cleaner.

During detergent operation, the detergent container (5, Fig. 4-2) must be sufficiently filled with approved detergent. The filter of the detergent suction hose must be completely inserted to the bottom of the container.

Intake air or inadmissible detergents causes damage to seals and pump.



Approved cleaning detergents

An up-to-date list of approved detergents or chemical additives can be requested from the manufacturer EHRLE.

For cleaning work with the high pressure cleaner, a detergent agent (chemical) can be added to the high pressure jet.

The detergent can be fed from one of two detergent containers (see Fig. 4-2).

Place the detergent containers so that the lower level of the cleaning detergent is max. 0.8 m below the bottom of the unit.

The cleaning detergent containers can be placed above the device as the chemical and detergent flow is interrupted by non return valves fitted as standard. An uncontrolled overflow into the float container and backwards into the detergent container is not possible.

In order to protect the environment, we recommend using detergents sparingly. Observe the dosage recommendations on the container labels of the detergents.

For cleaning detergent operation proceed as follows:

- ▶ Provide detergent container (see Fig. 4-2).
- ▶ Fill or top up (if necessary) the detergent container with approved detergent
- ▶ Insert the filter of the detergent suction hose to the bottom of the detergent container.
- ▶ Initially set the detergent control valve (see 3, Fig. 6-1) into position „0“.

- ▶ Open the detergent control valve from position „0“ according to the desired quantity of detergent. The detergent container is selected by the direction of rotation
 - to the left, the left detergent container is selected
 - to the right, the right detergent container is selected.



General Information

The more the detergent control valve is opened, the more amount of detergent is sucked in. Depending on the application area, set the dosage via the detergent control valve.

-
- ▶ To remove the dirt, spray on the detergent sparingly onto the cleaning object and let it work for approx. one to five minutes
 - ▶ Then spray off the loosened dirt with the high pressure jet.
 - ▶ After using detergents, set the detergent control valve to „0“. In normal operation, rinse the high pressure cleaner for at least 30 seconds.

7 Decommissioning



General Information

Provide a frost sheltered location for the high pressure cleaner as well as all accessories (trigger gun, spray lance, water inlet hose, etc.) for

- temporary storage until the next operation or
- storage over a longer period of time.

Otherwise provide frost protection (see section 8.3.1).

7.1 Temporary decommissioning

After completion of cleaning work for temporary decommissioning until the next use, proceed as follows:

- ▶ After cleaning detergent operation according section 6.4.2
 - set the detergent control valve (3, Fig. 6-1) to position 0
 - rinse the high pressure cleaner for at least 30 seconds.
- ▶ If necessary, set the device switch 0/1 to position 0.
- ▶ If necessary, close the shut-off valve of the tap water network on the building side.
For hot water inlet up to 80 °C, close the shut-off valve of the pipeline. Make sure that the device parts as well as the cleaning objects have cooled down before touching them.
- ▶ Pull trigger lever of trigger gun (4, Fig. 6-2) until the high pressure cleaner is depressurised.



WARNING

Lock the lever of the trigger gun after completion of cleaning work.

After deactivating the trigger gun, lock the trigger lever (4, Fig. 6-2) against unintentional switching on by means of the locking lever (5, Fig. 6-2). Ensure that the locking lever is correctly positioned in the notch for the locking lever (6, Fig. 6-2).

Unintentional activation of the trigger gun after restarting the device can endanger life and limb of persons.

- ▶ Lock the trigger lever (4, Fig. 6-2) of the trigger gun against unintentional switching on using the locking lever (5, Fig. 6-2). Ensure that the locking lever is arrested in the notch for locking lever (6, Fig. 6-2).
- ▶ Remove HP-Hose from the trigger gun.
- ▶ To empty the high pressure pump, hold the HP-Hose and switch on the device only until no more water escapes at the end of the hose.
- ▶ Disconnect the power cord plug from the electrical mains socket.
- ▶ If necessary, wind up the power cord on the device holder.
- ▶ Roll up HP-Hose.

- ▶ If necessary, switch off the main switch or circuit breaker of the mains connection (e.g. building connection) for the power supply of the device.
- ▶ Stow the accessories.

7.2 Decommissioning for a longer period of time

If the high pressure cleaner is to be taken out of operation for a longer period of time, refer to Section 7.1 and take it out of operation.

After decommissioning for storage over a longer period of time, store the device and all accessories (trigger gun, spray lance, water inlet hose, etc.) in a frost-protected location.

Otherwise refer to Section 8.3.1, Frost Protection.

8 Maintenance



WARNING

Carry out maintenance measures professionally.

Maintenance measures may only be carried out by authorised personnel (see Tab. 8-1).

Before carrying out any maintenance work, disconnect the power cord plug (see section 3, device views) from the mains connection (e.g. building connection)

8.1 General Information

The maintenance measures must be carried out professionally, regularly and mean for the device:

- Guarantee of operational safety.
- Achieving a long service life.
- Maintaining the performance.

8.2 EHRLE Maintenance and Inspection Contract

With the sale of the high pressure cleaner the manufacturer EHRLE offers a maintenance contract or especially a safety inspection agreement. The maintenance contract includes:

- Maintenance and repair work.
- Safety inspection agreement.

The safety inspection agreement includes the inspection according to

- Guidelines for Liquid Sprayers (see Section 2.9).

8.3 Maintenance work

Components which show increased wear or whose design duration has been exceeded or is exceeded before the next maintenance must be replaced as a precaution.

Replace defective parts. Only use spare parts recommended and approved by the manufacturer.

The following table contains the periodical maintenance work for the Stationary High Pressure Cleaners Series KS.

Period	Component	Measure	Authorized personnel
Daily	Trigger gun	Check if trigger gun closes tightly; check function of mechanical locking to prevent unintentional switch-on; replace defective trigger gun.	Trained operator
	HP-Hoses	Check the HP-Hoses (see section 8.3.3).	Trained operator
	Electrical plug and cables	Check plugs and cables for damage. Replace damaged plugs and/or cables immediately by an authorized customer service/electrical specialist.	Customer Service/ Electrical Specialist
	High pressure pump	Check pump for leakage. If more than 3 drops per minute call customer service. Note: Due to condensate, higher drop formation is possible.	Customer Service
	High pressure pump	Oil leakage	Customer Service
Weekly resp. 8 operating hours	Water inlet filter	Check filter for dirt and clean if necessary (see section 8.3.2).	Trained operator
	Filter (detergent suction hose)	Check filter for dirt and clean if necessary	Trained operator
	Oil level high pressure pump.	Change low quality oil (e.g. milky or aqueous oil). Condensation is possible with high humidity and temperature fluctuations. If the oil takes on a grey or whitish hue, it must be changed. For oil change see section 8.3.4.	Trained operator or Customer Service
Semi-annually or if required	Spray nozzle	Replace spray nozzle.	Trained operator
Semi-annually	High pressure pump	Oil change (see section 8.3.4)	Customer Service
Annually	Safety check for the high pressure cleaner.	A qualified expert has to inspect the high pressure cleaners in accordance with the „Guidelines for liquid sprayers“, if necessary or at least every 12 months (see section 2.9). The result of the test must be recorded in writing. Carry out a safety check in accordance with the respective national regulations of the legislator for liquid sprayers.	Qualified expert

Tab. 8 - 1 List of maintenance work

8.3.1 Frost Protection

For optimum protection, operate or store the device in a frost-protected area.

If the device is exposed to temperatures below freezing point during temporary or prolonged decommissioning (e.g. storage in warehouse), frost protection must be provided (see section 8.3.1.1 and section 8.3.1.2).

8.3.1.1 Drain water from high pressure cleaner

Proceed as follows:

- ▶ Unscrew the water supply hose and the HP-Hose.
- ▶ Operate the high pressure cleaner for max. one minute until the pump and hoses are empty.

8.3.1.2 Rinse high pressure cleaner with antifreeze agent



General Information

Observe the handling instructions of the antifreeze manufacturer.

Proceed as follows:

- ▶ Provide commercially available antifreeze to the connection water inlet and connect the water supply hose.
- ▶ Place the collecting container under the high pressure outlet.
- ▶ Switch on the high pressure cleaner and operate until the antifreeze emerges at the high pressure outlet.

It also provides corrosion protection.

8.3.2 Filter in the water inlet



WARNING

Danger of skin burns due to hot surfaces or scalding by hot water.

In installations for hot water supply up to 80 °C, the piping must be unscrewed for access to the filter.

During operation with hot water inlet, the surfaces of the high pressure cleaner (pump parts, metal parts of the spray lance, cleaning objects etc.) or piping for the water inlet can become hot.

Touching hot surfaces or contact with hot water can cause skin burns or scalds. Avoid skin contact with hot water. Make sure that the device parts, cleaning objects as well as the piping of the water inlet have cooled down before touching them.

To clean the water inlet filter proceed as follows

- ▶ Close the water supply from the tap water network via the shut-off valve.
- ▶ To access the water inlet filter in installations with

- water inlet hose: unscrew the water inlet hose from the water inlet filter.
- piping for hot water supply up to 80 °C: unscrew the piping from the water inlet filter.
- ▶ Clean the water inlet filter.
- ▶ Reassemble in reverse order.

8.3.3 Checking the HP-Hoses



WARNING

Operation with worn, damaged or repaired HP-Hoses can endanger life and limb of persons.

Ensure that HP-Hoses are removed immediately in the case of:

- Signs of wear.
- Signs indicating repairs to the HP-Hose.
- Overaging and low durability.

Bursting or leaky HP-Hoses can cause high pressure water or hot water (in installations with hot water supply) to escape. This can endanger life and limb of persons.

Before each commissioning of the high pressure cleaners, carry out a visual inspection of the HP-Hoses for damage. Every HP-Hose must comply with the safety regulations and be marked with:

- Permissible operating pressure.
- Permissible operating temperature.
- Date of manufacture.
- Manufacturer.

Replace the HP-Hose at the slightest sign of damage.

Only use spare parts recommended by the manufacturer (see spare parts catalogue).

8.3.4 Oil change

For the oil change, use the oil specified by the manufacturer with the correct consistency.

Environmental protection requirements must be complied with and proper disposal must be ensured.

9 Troubleshooting



WARNING

Carry out troubleshooting and rectification properly.

After determining the possible cause of the fault, only authorised personnel may carry out the the troubleshooting and rectification (see Tab. 9.1).

Before carrying out any troubleshooting activities, take the high pressure cleaner out of operation and disconnect it from the building's (resp. infrastructure) electrical power supply.

9.1 Troubleshooting table

For troubleshooting purposes, possible error causes are listed in the following table.

Clean the contaminated parts (filter, high pressure nozzle, etc.) to eliminate possible faults.

Replace defective parts. Only use spare parts recommended and approved by the manufacturer.

Error	Possible cause	Remedying	Authorized personnel
Device cannot be switched on.	Check that the power supply cable is plugged in.	Connect the power supply cable to the building`s (resp. infrastructure) power supply.	Trained operator
	Circuit breaker of the mains voltage (building connection, infrastructure) has tripped.	Switch the circuit breaker on again.	Trained operator
	Circuit breaker trips again after repeatedly switched on.	If building power supply is ok, the device is defective; disconnect power supply cable, contact customer service.	Customer Service
	Check for defective power supply cable.	Replace defective power supply cable.	Customer Service / Electrical Specialist
	Internal device control or components defective.	Replace defective components.	Customer Service
Device has switched off in stand-by mode.	Device was in stand-by mode for 20 minutes. Electronic control has switched off high pressure cleaner according to program.	To resume operation, turn the device switch 0/1 into position 0 and then back to operating position 1.	Trained operator

Tab. 9 - 1 Troubleshooting table

Error	Possible cause	Remedying	Authorized personnel
Pump operation unstable, provides no performance during cleaning detergent operation.	Detergent container is empty or the filter of the detergent suction hose is not inserted to the bottom.	Fill or top up (if necessary) the detergent container with approved detergent resp. insert the filter of the detergent hose to the bottom of the detergent container.	Trained operator
Device switched off during operation.	Motor of high pressure cleaner overheated.	Allow motor to cool down. To resume operation, turn the device switch 0/1 into position 0 and then back to operating position 1.	Trained operator
	After further attempts to switch on, the device does not go into operation.	Contact Customer Service.	Customer Service
	Internal control circuits or components defective.	Replace defective components..	Customer Service
No pressure build-up with high pressure cleaner.	High pressure nozzle dirty or defective.	Clean or replace high pressure nozzle.	Trained operator
	Water inlet filter dirty.	Clean the filter, see section 8.3.2.	Trained operator
	Water inflow volume is too low (see section 3.5, Technical Data).	Ensure sufficient water inflow volume.	Trained operator
	Air has been sucked into the device, water supply or hose.	Vent the device or hoses.	Trained operator
	One or more supply lines of the pump are leaking or clogged.	Replace leaking supply pipes or remove blockage.	Customer Service
	Unloader valve contaminated.	Clean the unloader valve.	Customer Service
	Unloader valve is defective.	Replace defective unloader valve.	Customer Service
	High pressure pump valves are dirty or defective.	Clean or replace valves.	Customer Service
Cuffs of the high pressure pump are dirty or defective.	Clean or replace cuffs.	Customer Service	

Tab. 9 - 1 Troubleshooting table



Notes

Proof of customer service

Device type	Manufacturer no.:	Commissioning on:
-------------	-------------------	-------------------

Inspection carried out on:

Findings:

Signature

Inspection carried out on:

Findings:

Signature

Inspection carried out on:

Findings:

Signature

Inspection carried out on:

Findings:

Signature

EHRLE GmbH • 89165 Dietenheim / Germany

EHRLE service near to you? Adresses, phone numbers etc. you will find under www.ehrle.com.

Subject to change without notice. Reprint prohibited.

